



Thinking solutions.

Vacuum spray-tube degassing



Servitec

Reflex— a powerful brand for decades

Reflex Winkelmann GmbH is a leading provider of highquality heating and hot water supply technology systems. Under its Reflex brand, the company, which has its headquarters in Ahlen in the German region of Westphalia, develops, produces and sells not only diaphragm expansion vessels, but also innovative components and holistic solutions for pressure maintenance, water make-up, degassing and water treatment, storage water tanks and plate heat exchangers, as well as hydraulic manifold and tank components. Reflex Winkelmann GmbH has about 2,000 employees worldwide, giving it an international presence in all major markets.

With its energy-efficient and sustainable products, the company is already doing its bit to help the environment, as evidenced by its commitment to sustainability and the climate policy goals agreed by the German Federal Government. This support is built on proven technologies and future-oriented innovations. What's more, Reflex Winkelmann GmbH works together with others as equals, always maintains its focus on the customer and offers additional services such as its own factory service centre fleet and a comprehensive range of training options.

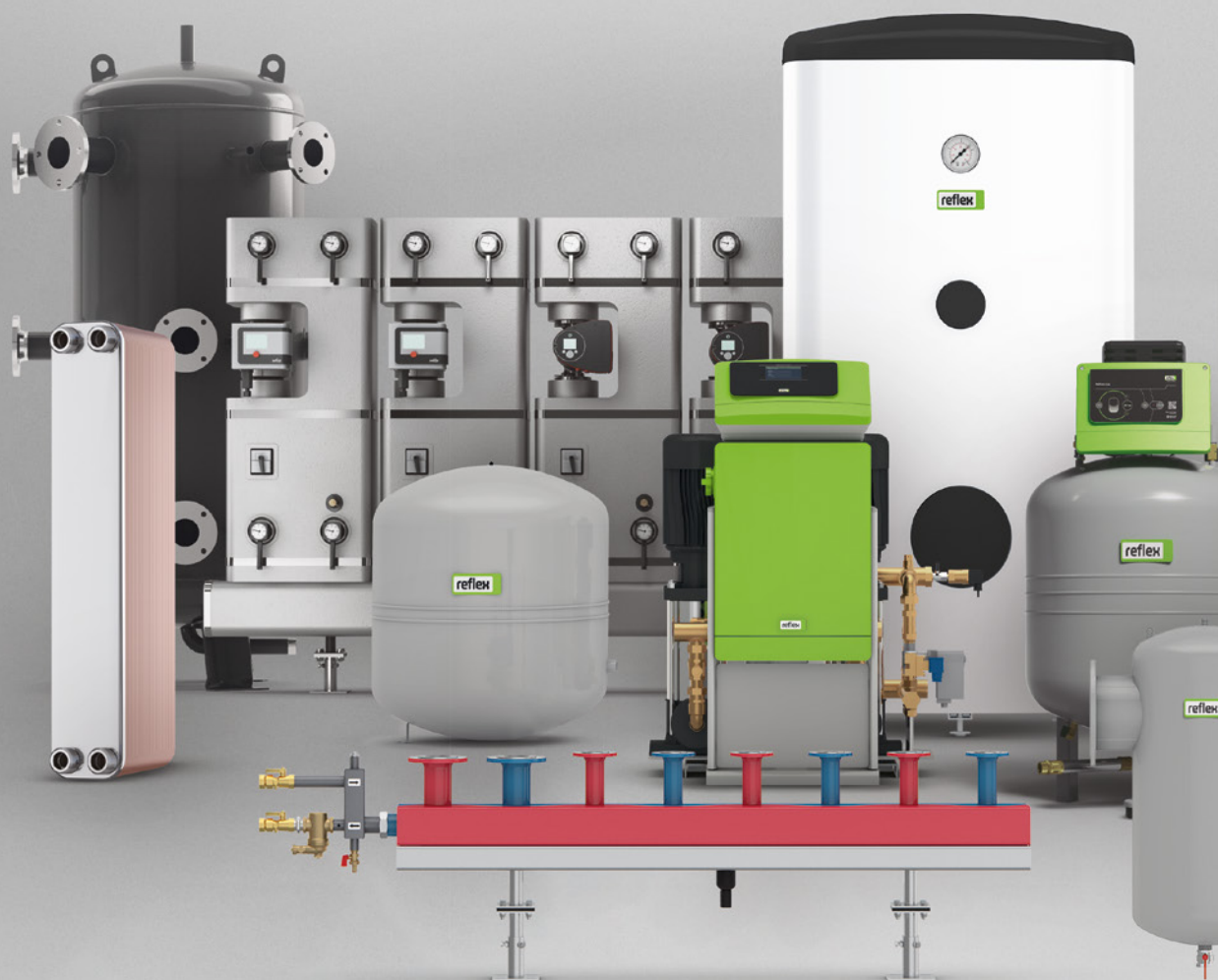



Contents

Reflex City	P. 4
Servitec degassing	
Key advantages	P. 6
Background information on water quality	P. 9
Construction, function and application	P. 14
Servitec product overview	P. 17
Reflex Control controllers	P. 18
Selection and calculation	P. 24
Installation and commissioning	P. 25
Installation examples	P. 28
Special solutions	P. 30
Services	P. 32

Our configuration software



Reflex Solutions Pro
rsp.reflex.de/en

→ Read more on [page 32](#)

Reflex City

Servitec special solution

Servitec Mini





Servitec 60

Servitec S

Efficient degassing solutions of any size

Living, shopping, working, manufacturing: cities are synonymous with diversity. The requirements for supply technology are as individual as the buildings themselves. Whether it's a 5 kW facility in a detached home or a safety-related cooling system in a computer centre—Reflex offers products and solutions for systems of all sizes and complexities. As shown in our Reflex City concept.

Our Servitec degassing systems ensure maximum comfort. Thanks to the increased water quality, homeowners benefit from more living comfort, installers from reduced maintenance costs and system operators from long-term operational reliability and efficiency. Servitec systems are available for virtually any system size and can be used in heating, cooling and district heating systems.

Servitec vacuum spray-tube degassing

Key advantages

Powerful, central degassing of content and make-up water

- Actively degases even dissolved gases; separates up to 90 %
- Extremely efficient, confirmed by impartial institutes and tests

Lasting operational reliability of the entire heating/cooling system

- Protects against long-term damage from corrosion and deposits, resulting in less maintenance and a longer service life of the entire system
- Prevents plant failure caused by gas and air pockets

Optimum heat transfer medium for improved performance

- Optimises heat transfer, reduces energy costs and CO₂ emissions
- Patented valve switch mechanism for fully automated hydraulic balancing
- Efficiency improvement can be maximised by combining with Exdirt dirt and sludge separators

Easy installation and commissioning

- Plug-and-play function
- Auto setup for easy and safe commissioning

Highly modern, user-friendly controller

- With extendable microprocessor controller, Reflex Control*
- Enables communication between Servitec systems, Reflex pressure maintenance stations, the Fillcontrol range, and a control centre
- Fully automatic operation with data interface for incorporation into modern building management*
- Servitec Mini and Servitec S with app control using Reflex Control Smart

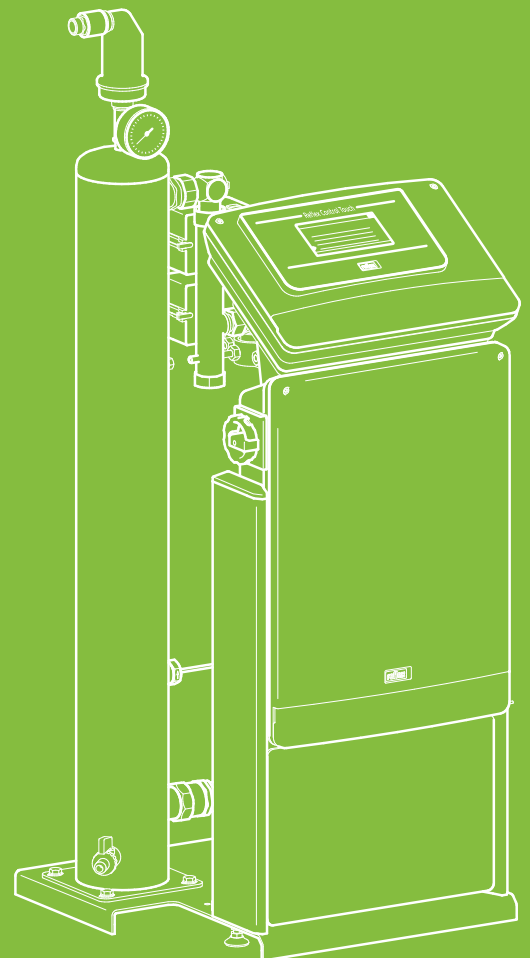

* Doesn't apply to Servitec Mini, which is accessed via Reflex Control Smart and Bluetooth.

Servitec solves the gas problem in heating and cooling systems

Gas pockets in water heating/cooling systems can impair their functionality to the extent that entire components and systems can break down completely. They reduce energy transmission efficiency and create resistance and the risk of corrosion. Corrosion encourages the formation of dirt and sludge in heating and cooling circuits which, in turn, can result in further impairment of the entire system. Degassing systems such as Servitec

vacuum spray-tube degassing offer a centralised means of removing virtually all gas bubbles and dissolved gases from the system water. Problems with air are reliably mitigated, even in large-scale branch systems with intricate surface heating facilities. This results in optimised system hydraulics with a gas-free heat transfer medium for efficient heat transfer and a longer service life of heating and cooling systems.

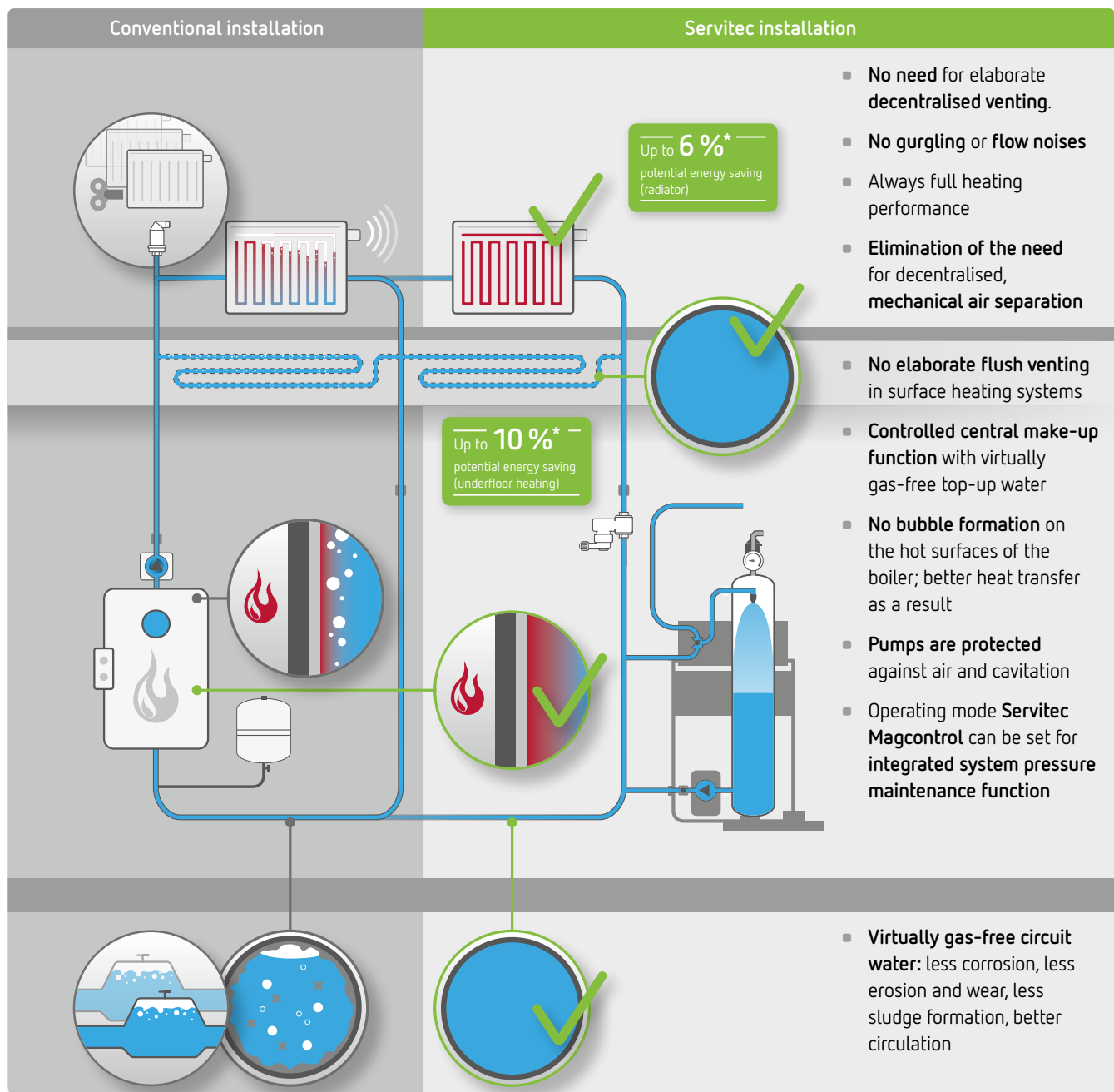

* Result from simulation under laboratory conditions

Comparison using a cold water system as an example

Water is the medium that plays a key role in cold water systems as an important system component and the most frequently used source of energy in building facilities. Accordingly the same applies to optimising the system water in terms of degassing as for heating systems. As the solubility of gas in water is dictated by pressure and temperature, cold water in its natural

state already contains a much higher share of dissolved gases compared, for example, to water in heating systems. If the water temperature falls, as well, as is the case with cooling systems, gas absorption increases. As such, using Servitec to actively degas dissolved gases as well is particularly recommended.

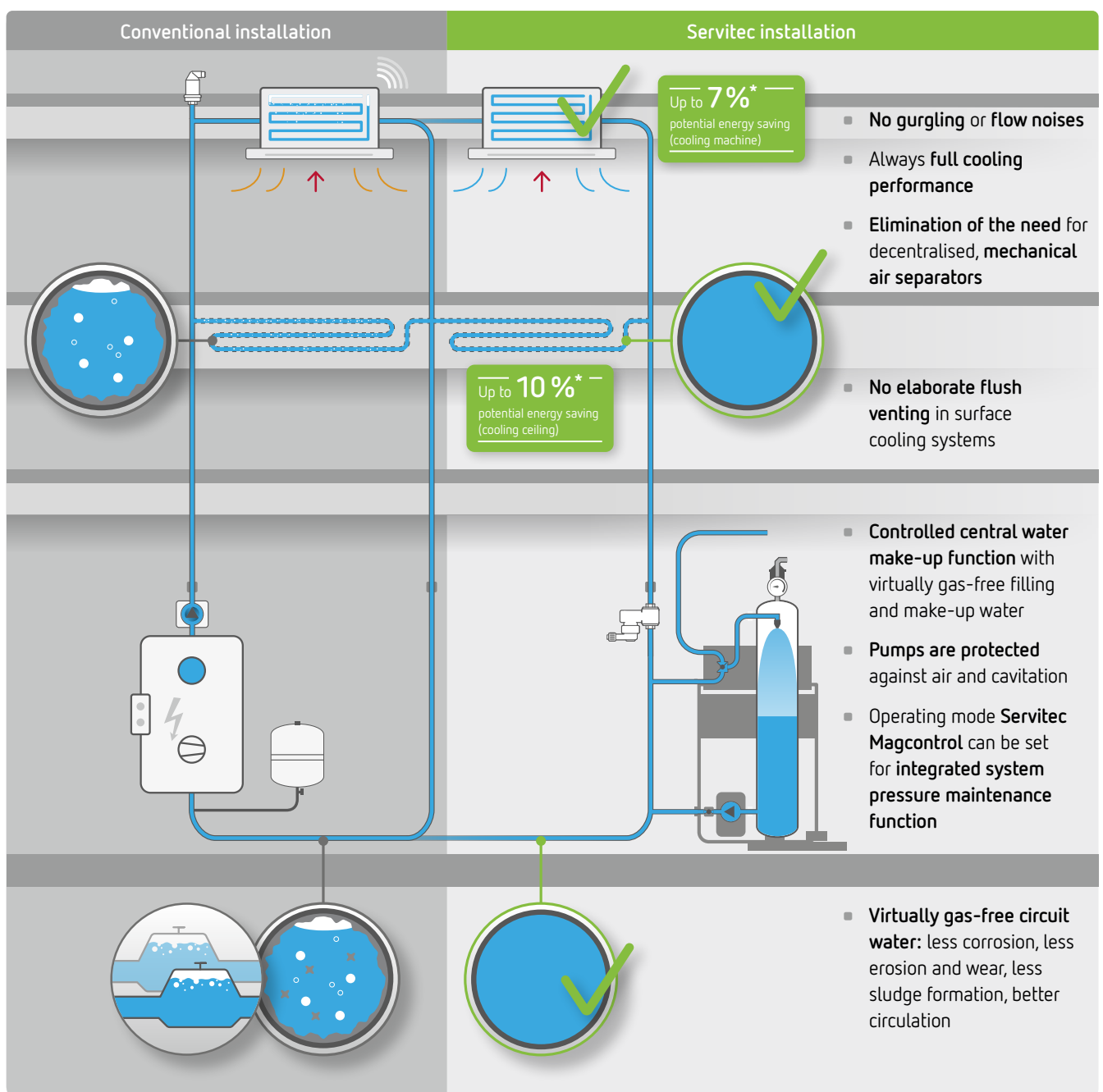

* Result from simulation under laboratory conditions

Background information on water quality

Water as the most important system component

Energy in heating and cooling systems is defined as the amount of input power that ultimately ends up hot or cold. Two key factors play a role. Firstly, the use of input energy to adjust the temperature of the heat transfer medium—which is usually water. Secondly, the transportation and, especially, dispersion of heat, or absorption in the case of cooling applications. The essential prerequisite for the appropriate and efficient distribution of heat is an uninterrupted flow of volume and mass into each part of the system.

> Oxygen

The oxygen in air is the main cause of corrosion of iron materials. Oxygen in a heating or cooling system reacts quickly and, if continuously fed in, can cause damage in the long run. So-called acid corrosion can be neglected at proper pH, and the concentration of dissolved oxygen in the water determines the corrosion. The particles formed in the chemical reactions can deposit on the inside of the tube and act as an insulating layer. If the process continues to repeat itself through the typical mechanisms of air and gas infeed, this can lead to a reduction in heat transfer as well as to corrosion phenomena and damage to system parts after just a few years of operation.

> Nitrogen

By contrast, nitrogen is an inert gas that does not react. It remains dissolved in the system water in the form of micro-bubbles and continues to accumulate. The solubility of nitrogen in water is dependent on temperature and pressure (Henry's Law). The lower the pressure and the higher the temperature, the less nitrogen can be bound by water. In large quantities, the water can no longer bind a gas and so it occurs freely in bubble form. Highest points and relatively calm spots tend to favour the precipitation of nitrogen bubbles, which means that these areas can be prone to malfunctions and disrupted circulation if nitrogen accumulates accordingly. The hydraulic system malfunctions and heat exchange performance in the heating and cooling elements is impaired. The hydraulic balancing process loses its effect and can even lead to the failure of individual parts of the system depending on the gas and air inclusions.

Air—and the gases it contains—is the enemy of every system

The main components of air are nitrogen (78 %) and oxygen (21 %). Keeping things simple, these gases can be found in 10-degree water at a ratio of 62 % nitrogen and 38 % oxygen. System water always contains dissolved nitrogen and oxygen as a result of the filling and top-up water.

Each of the two elements has a different effect.

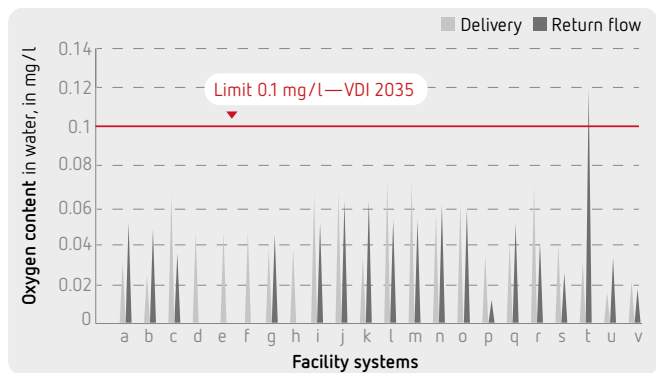

Oxygen content in the circulation water of different facility systems (field measurements performed by Dresden TU)

The illustration above depicting field measurements of the oxygen content in the circulation water of different facility systems performed by Dresden TU, Germany and documented in Report AiF (2002) shows clearly how willingly oxygen reacts with system components. In virtually all instances, the measured oxygen content is below the limit of 0.1 mg/L specified in VDI 2035. Corrosion uses up virtually all the oxygen in the system.

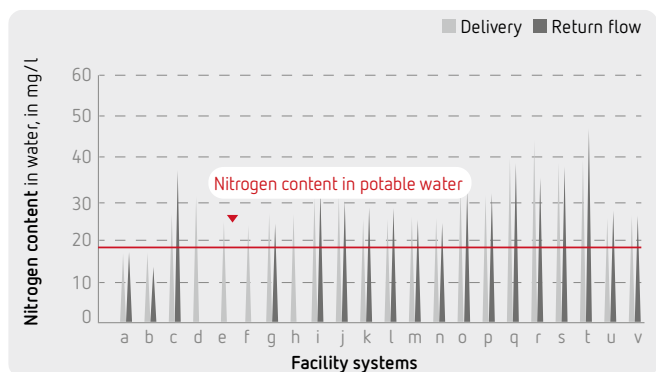

Nitrogen content in the circulation water of different facility systems (field measurements performed by Dresden TU)

An analysis of the field measurements of the nitrogen content in the circulation water of different facility systems in the aforementioned report shows an accumulation of nitrogen concentration that is, in most cases, higher than the natural concentration of 18 mg/L. In 95 % of the examined trouble systems, free nitrogen proved to be the cause of gas, and consequently circulation, problems.

Energy characteristics of high-gas and low-gas media

Compared to pure water, nitrogen has far poorer thermodynamic properties as a heat transfer medium. The specific heat capacity of water is four times above that of nitrogen, while its thermal conductivity is about 20 times higher. To reach the target temperatures on the receiver side therefore requires more work in the form of energy, depending on the nitrogen concentration involved. Depending on its configuration, the system will therefore continually try to balance itself by feeding in more or less energy. In other words: energy is wasted, costs are higher, and temperature regulation performance is impaired.

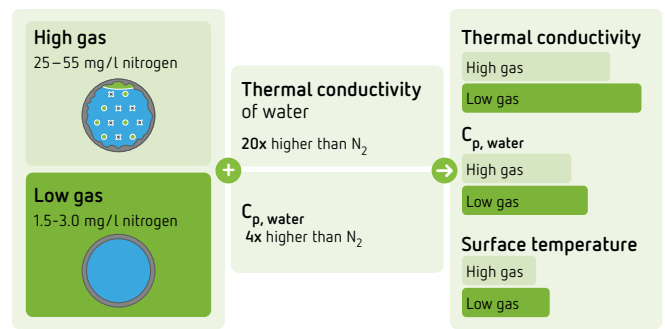

Gas accumulations in the system water and its thermodynamic impacts

How gas gets into the system

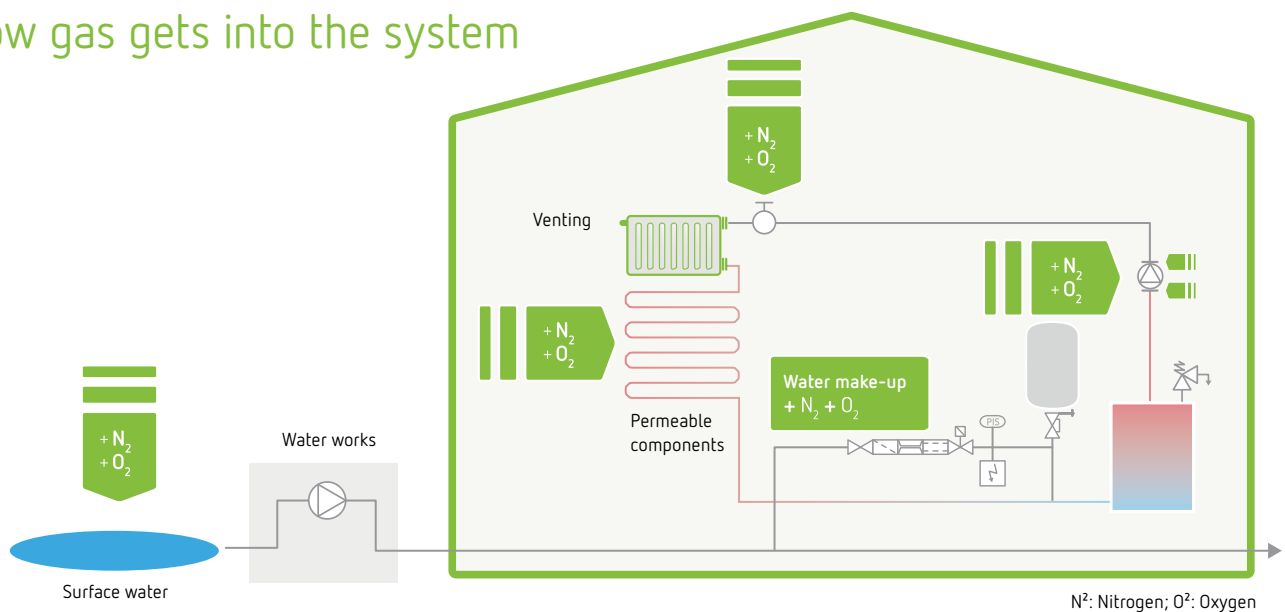

Schematic representation of air and/or gas ingress into a system

- Through filling and make-up water**
 Potable water naturally contains 18 mg/l nitrogen and 11 mg/l oxygen.
- Through residual air when refilling and topping up**
 After repairs, for example. Studies show a strong charge in the filling water, which is far above the natural value of the potable water and therefore has other causes.
- Through permeable system components**
 In comparison to traditional building materials such as steel and copper, a considerable amount of air can diffuse into the system through plastic and rubber tubes.
- Through chemical reactions**
 Corrosion and decay can cause gases to be released. In some facilities, for example, larger amounts of nitrogen and methane are detected in the system water.
- Through air intake**
 In the case of a pressure maintenance malfunction, for example. Air frequently gets into the facility system through failure to reach the minimum operating pressure. This is why, in the event of any air problems, you should always check the exact function and setting of the pressure maintenance first.

Water heating and cooling systems are watertight.
 No water heating and cooling system is gastight.

Heating and cooling with optimised system water

Appropriate, preferably centralised, equipment must be used to extract gas from sealed systems. In addition to conventional thermal degassing in hot water systems >110 °C, three methods have become commonplace in heating, solar and cooling water systems, which Reflex can supply for various applications: Vacuum spray-tube degassing, atmospheric degassers and micro-bubble separators.

Henry's Law

Henry's Law (named after English chemist William Henry) describes the solubility properties of gas in liquid. The associated physical characteristics are used in degassing and separation technology. The Servitec vacuum spray-tube degassing technology developed by Reflex makes use of the physical behaviour of gas in liquid as described in Henry's Law, The Law defines the solubility behaviour of gases in a liquid as follows:

The concentration of a gas in a liquid is directly proportional to the partial pressure of the gas above the liquid.

In other words: If the partial pressure of the gas above the liquid increases, the number of particles dissolved in the liquid also increases. If the partial pressure decreases, gas particles diffuse out of the liquid. In order to exploit this effect, a vacuum is created in the Servitec spray-tube. The combination of spraying and the large contact area within this sphere leads to the release of the dissolved gases, which are extracted by an air vent.

The figure below represents the maximum solubility of nitrogen in water according to Henry. Solubility decreases as the temperature rises and the pressure falls. That explains, for example, why radiators upstairs often suffer from circulation problems. Assuming for pressure maintenance purposes that the minimum overpressure is set at 0.5 bar relative to the highest point, the solubility of nitrogen at a supply temperature of 70 °C is 15 mg/l (example in below graphic). Nitrogen concentrations of ≤ 15 mg/l generally do not present problems.

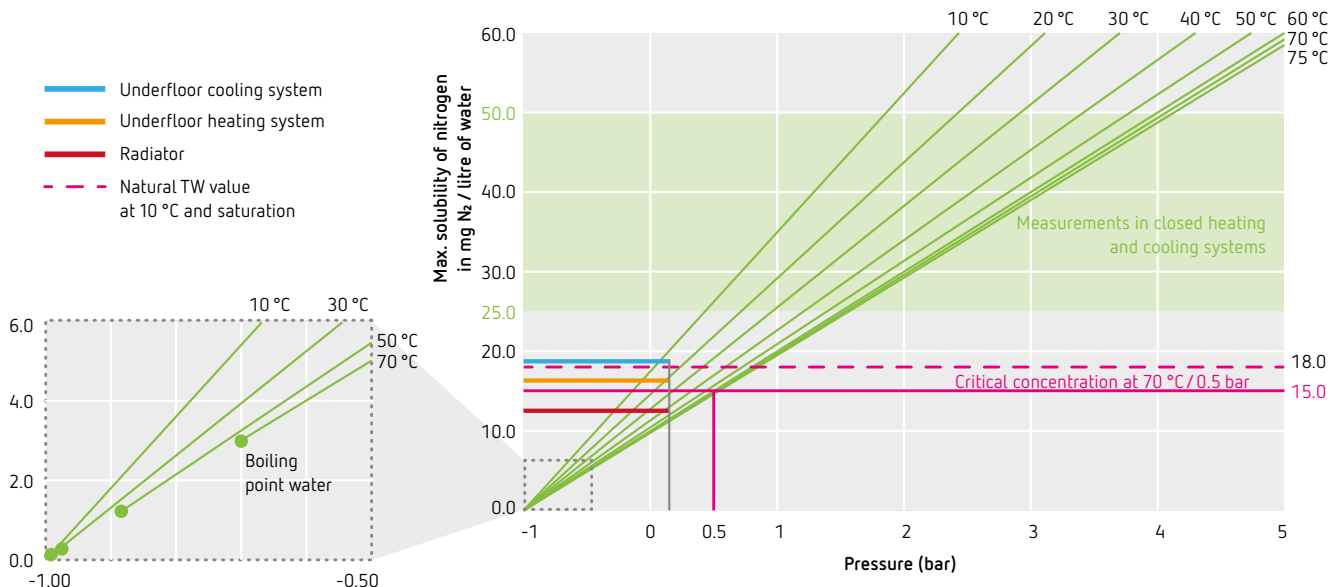

Maximum solubility of nitrogen in water according to Henry

Reflex degassing and separating products: A comparison

To visualise the effectiveness of the various degassing systems, we want to show the physically and technically possible minimisation of nitrogen content in tap water, depending on the pressure conditions at the location of installation.

Nitrogen was used as the measuring gas as—because of its inert nature—it is not used up in secondary reactions and therefore does not distort the measurement result.

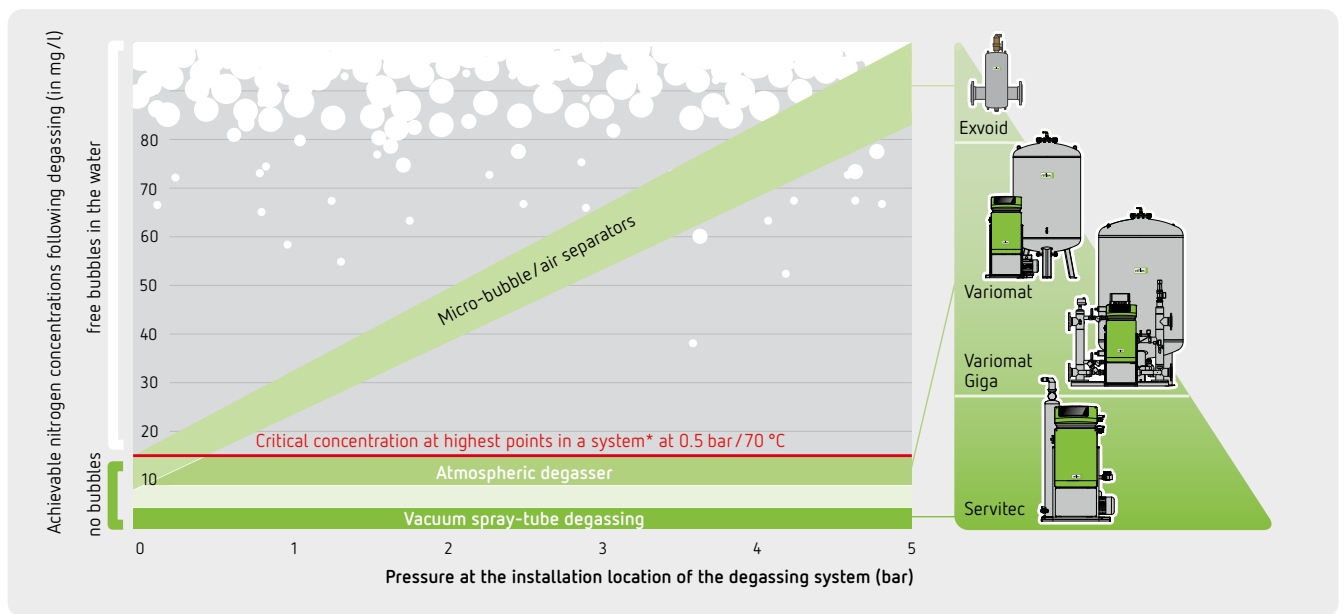

Degassing performance of Reflex products

Mechanical air separators: **Exvoid/Extwin**

Can only extract free gas, not dissolved gas. They are most effective when installed at the absolute highest points. Since most facilities nowadays are designed with the manifold at the bottom, however, they are usually installed in less favourable, lower positions which compromises effectiveness enormously.

Atmospheric degassers: **Variomat**

Can prevent free gas bubbles in the circulation water. Are best suited as centralised venting systems but not specifically for oxygen extraction. Erosion caused by two-phase flow can be largely avoided.

Vacuum spray-tube degassing: **Servitec**

Can reduce the entire gas content to virtually zero and combats both corrosion (reactive gases) and erosion (inert gases). Gas solubility is virtually zero in a vacuum. Nevertheless, the degassing performance of static vacuum degassers is poor because of the idle vacuum. Excellent degassing performance is only achieved through stimulation, e.g. by spraying water in the vacuum (vacuum spray-tube degassing). Consequently, vacuum spray-tube degassing is one of the most efficient technologies available in the marketplace.



- Gas undersaturation at the critical system point* can only be achieved with degassers.
- Vacuum spray-tube degassing can achieve virtually complete elimination of the gas.
- When filling or topping up using vacuum spray-tube degassers, undersaturation is achieved and, above all, the oxygen content in the filling water is reduced by about 2/3.

* Critical system point (KP) = point during operation at which the greatest risk of bubble formation exists (e.g. highest points, heat generators, control valves, pumps), which must, however, be prevented to avoid malfunctions. It is the reference point for calculating the achievable gas saturation performance of degassers and gas separators.

Proven efficiency

Greater efficiency means less environmental pollution and lower costs despite maximum temperature regulation performance. Reflex Winkelmann has a range of product solutions on the market that are capable of increasing the efficiency of water heating and cooling systems by up to 10 %*. The results of the technological product potential were established independently by the ifes Institute (for applied energy simulation and facility management).

TÜV Nord was then commissioned to perform an independent verification of the study, which confirmed the maximum achievable energy saving effects. An added benefit for the environment and in terms of cost efficiency: In addition to saving emissions and energy costs, the system developed by Reflex also reduces maintenance and investment costs. This means everyone stands to benefit whether it's a private household, business or large-scale industry.

* Result from simulation under laboratory conditions

ifes Institute

Institute for applied energy simulation and facility management



Background

Design and organisation of a strategy that uses flow simulation to evaluate the use of Reflex degassing systems to raise the efficiency of heating systems.

TÜV Nord

TÜV NORD Systems GmbH & Co. KG



Background

Impartial evaluation of the simulation results with regard to the energy efficiency of Reflex degassing systems.

Simulation example: Radiator heating

15 kW Heating load



6%

Efficiency improvement in the simulated result under laboratory conditions**

In a typical existing detached house with 15 kW radiator heating, the use of Servitec vacuum degassing, Reflex pressure maintenance, and dirt and sludge separators can save around 2,000 kilowatt hours of heating energy or 500 kilograms of carbon dioxide per annum. This corresponds to a maximum increase in efficiency of 6%.

Simulation example: Underfloor heating system

30 kW Heating load



10%

Efficiency improvement in the simulated result under laboratory conditions**

The effects of the Reflex system in the simulation of a conventional existing semi-detached house with modern, low-consumption, low-temperature underfloor heating are even more pronounced: For a system with 30 kW heating, this represents a maximum saving of around 6,300 kilowatt hours of primary energy or 1.5 tonnes of carbon dioxide per annum. The increase in efficiency therefore amounts to a maximum of 10%*.

Practical example: Residential construction

13 kW Heating load



8%

Efficiency improvement measured in practice**

Residential construction companies have been using Servitec systems for several years. A Servitec Mini was installed in a 13-kW detached house with underfloor heating. Initial measurements show that substantially fewer kilowatt hours were billed compared to the previous year. Compared to a similar winter temperature-wise, efficiency was found to be 8% better.

Practical example: Cold water system

2.6 MW Cooling load

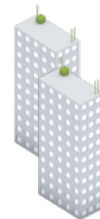

3%

Efficiency improvement measured in practice**

A Servitec 60 was integrated into the cold water system of a company from Singapore. Measurements and analyses performed by an external energy consultant and auditor verified a potential energy saving of 3% in practice (reduced energy transport and primary energy cost). This equates to 258 fewer tons of CO₂ every year and annual operating cost savings of about € 39,000.

** Relative to the energy generator's primary energy.

Construction, function and application

Servitec — construction

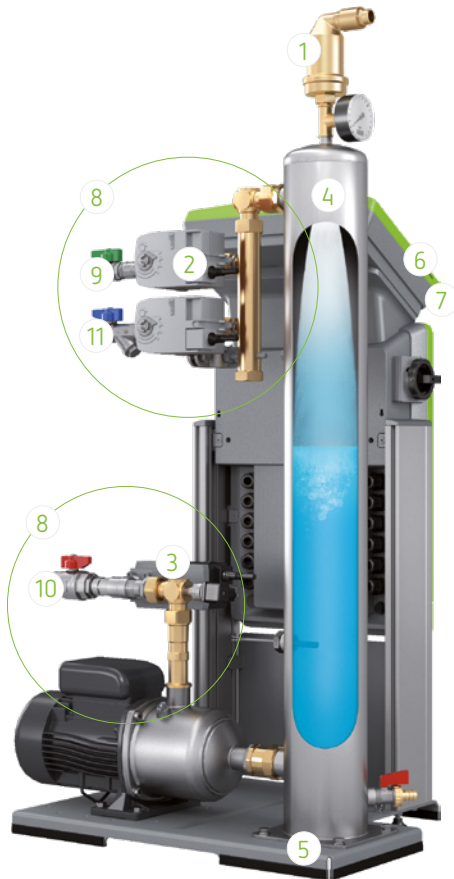

1. **Level tube degassing**
allows gases to escape and is vacuum-tight
2. **Fully independent protection of water make-up** with own 2-way motor ball valve for maximum operating safety
3. **Patented valve switch** for fully automated hydraulic balancing
4. **The vacuum spray tube**
Height and diameter are coordinated to guarantee atomisation of the water in a large free vacuum as soon as the degassing cycle starts
5. **Spray tube with 4-point-fastening** – robust, according to industry standard
6. **Controller**
The degassing cycles are performed at optimised intervals
7. **Hydraulics**
Integrated plug-and-play management by the controller adjusts the control ball valves to align the hydraulics automatically to the pressure conditions in the system
8. **Simple installation, maintenance and accessibility** thanks to new arrangement of connections
9. **Make-up water G ½"**
10. **Low-gas circuit water G 1"**
11. **High-gas circuit water G ½"**

Servitec Mini — construction

1. **Level tube degassing**
allows gases to escape and is vacuum-tight
2. **The vacuum spray tube**
Height and diameter are coordinated to guarantee atomisation of the water in a large free vacuum when the degassing cycle starts.
3. **Shut-off valve with filter insert**
4. **High-gas circuit water DN 15**
5. **Sturdy diaphragm pump**
6. **Low-gas circuit water DN 15**
7. **Integrated pressure sensor**



Servitec — operating principle

Vacuum generation (create vacuum)

The pump switches on, the water level drops and a vacuum is produced in the vacuum spray-tube.

The circuit water (optionally make-up water) is sprayed as a fine mist into the resulting vacuum and the dissolved gases are released due to the vacuum and large contact surface.

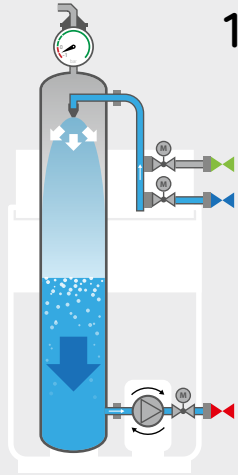

1

Degassing start

The pump switches off. Water continues to be sprayed until the vacuum spray-tube is completely full again. In the event of an active request for make-up water, a switch-over enables the degassing of gas-rich make-up water in the vacuum spray-tube.

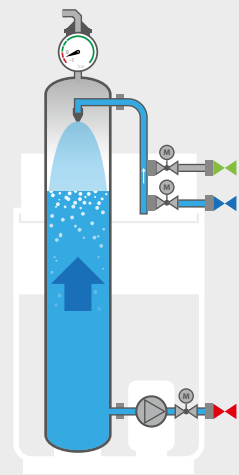

2

Discharge

All released gases are discharged safely by the automatic fan.

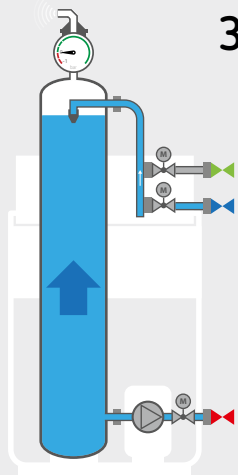

3

Idling time

System pressure prevails again in the spray tube. The system water located in the tube contains virtually no gas and is pumped back into the network in the next cycle.

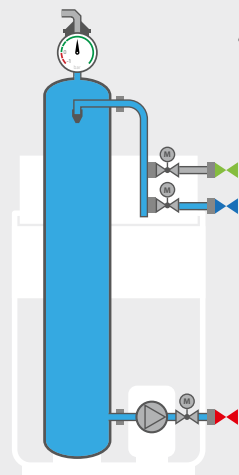

4

Servitec products actively degas even dissolved gases by extracting part of the flow of content water from the system, degassing it in the vacuum and returning it virtually gas-free back to the system. Automatic ball valves keep the partial flow steady, regardless of the pressure conditions in the facility.

Videos showing how this and other products work can be found at



[www.youtube.com/
@ReflexWinkelmannUnitedKingdom](https://www.youtube.com/@ReflexWinkelmannUnitedKingdom)



Applications

Reflex products offer reliable protection against gas and dirt problems in large and small systems. The standard portfolio covers system volumes of up to 220 m³ and can be integrated into existing and new buildings with ease. Servitec systems

are found in the widest range of buildings: centrally heated residential and industrial buildings, district heating systems, greenhouses, lawn heating systems in football stadiums, closed cooling circuits—and especially in systems with cooling ceilings.

Servitec Mini

- Compact, affordable solution for facility systems containing little water
- Application examples: Detached, semi-detached houses, apartment buildings, nursery schools, public offices, small businesses

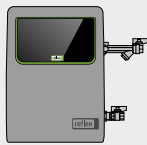

System capacities up to **100 kW**

Pressures up to **2.5 bar**

+1 m³ buffer storage
System volumes up to **1 m³**



Servitec S

- For small and mid-sized facilities
- Application examples: Apartment buildings, small school buildings, small business and office complexes

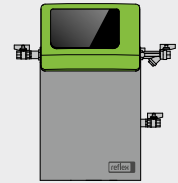

Pressures up to **4.5 bar**

System volumes up to **6 m³***



Servitec 35/60/75/95/120

- Technically sophisticated systems for mid-sized and larger facilities
- Application examples: Offices, industrial buildings, skyscrapers

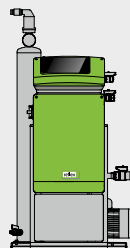

pressures up to **9 bar**

System volumes up to **220 m³**



Servitec special solutions

- Special solutions for larger facilities
- Special requirements, such as high temperatures and pressures, high make-up quantities, stainless steel models, etc.
- Application examples: Computer centres, district heating systems

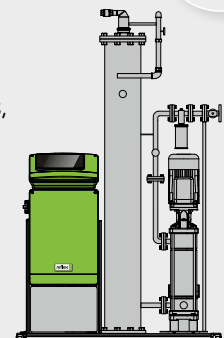

pressures up to **>9 bar**

System volumes **>220 m³**



Do your requirements extend beyond our standard products? Our Project Sales Team can customise a solution to suit your individual requirements: angebote@reflex.de

* Max. system volume for system degassing/check max. make-up quantities for each specific system.

Servitec product overview

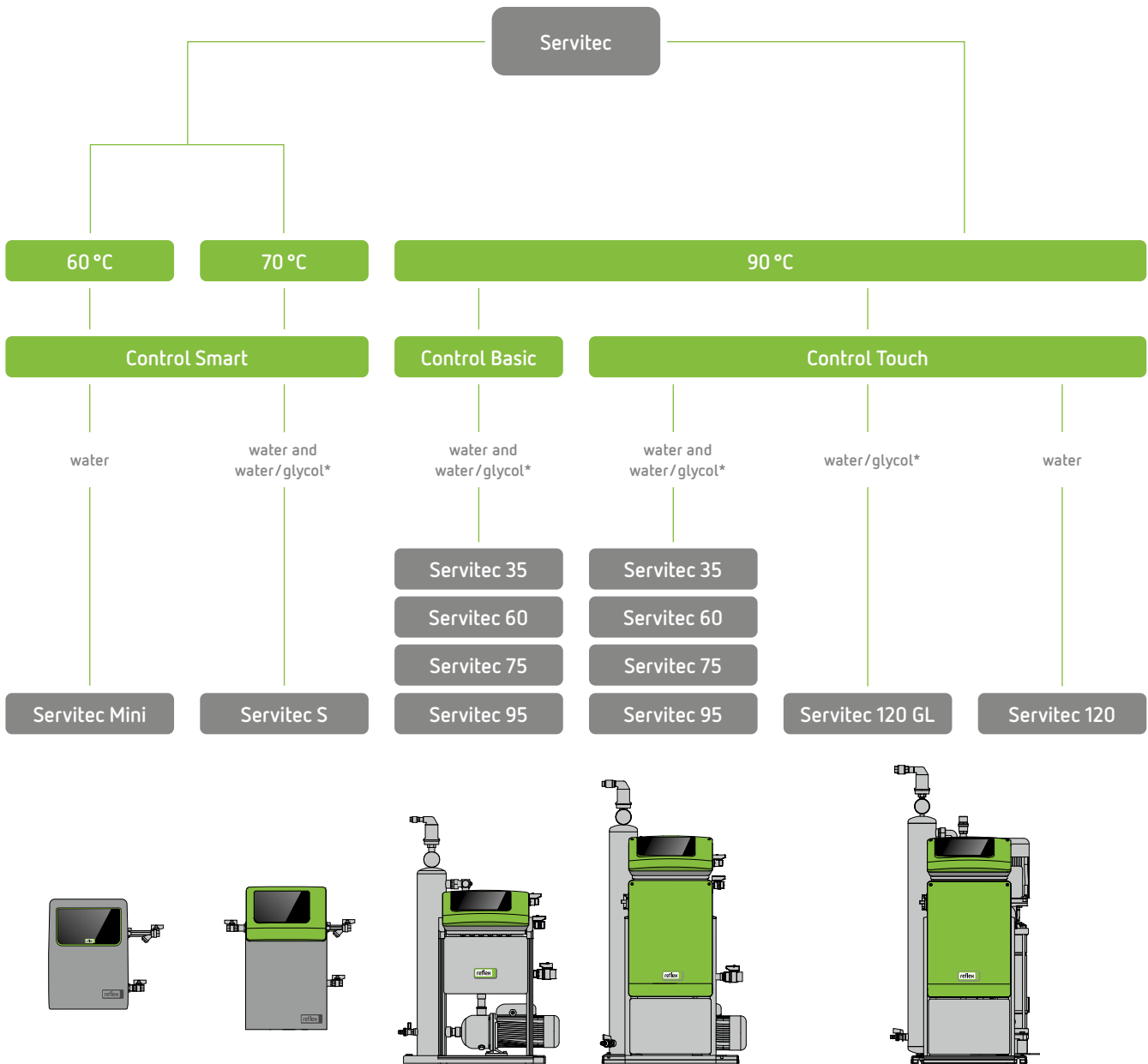

* Max. glycol content 50 %.

All Servitec units now with a new, wider range of applications:

- all in one: Servitec S to 95 immediately suitable for water-glycol applications
- operating temperature now permitted up to 90 °C (Servitec 35– 120)



Reflex Control controllers

Reflex Control systems

Control Basic



- 2-line LCD display
- 8 operating keys
- 2 status displays
- integrated control of system pressure, degassing and water make-up
- manual and automatic operation
- floating-contact external group fault signal
- counting pulse inlet for contact water meter
- RS-485 interface for BMS connection via Busmodules

Control Touch



- 4.3" touch screen colour display
- graphical user interface
- simply structured plain text menus, incl. operating instructions and help documentation
- integrated control of system pressure, degassing and water make-up
- manual and automatic operation
- permanent display of key operating parameters on system diagram
- intelligent plug-and-play function management
- key operating data can be analysed and stored
- wide array of interfaces:
 - 1 × meter pulse inlet for contact water meter
 - 2 × floating outputs for fault messages
 - 2 × analogue parametrisable outputs for pressure & level
 - 2 × RS-485 interfaces for connection to building management system and other networks
 - slots for HMS Networks and SD memory card

Control Smart



- access via Bluetooth interface
- quick and easy commissioning
- parameterisation of the degassing mode (continuous or intermittent operation, number of cycles) including days of the week and time
- fault message display
- system pressure checking
- software updates for the system control
- maintenance and troubleshooting wizard
- currently available for **Reflexomat XS**, **Reflexomat Silent Compact Smart**, **Servitec Mini** and **Servitec S**

Now available
for Android and iOS



Servitec product portfolio

Servitec Mini

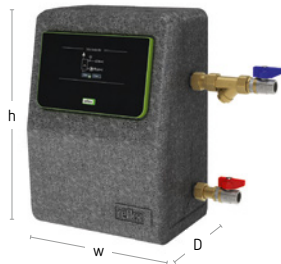

Servitec Mini

Servitec Mini & Fillcontrol Plus Compact

Servitec Mini – with Control Smart controller

Technical Features

- permissible operating overpressure 4 bar
- operating pressure 0.5–2.5 bar
- permissible operating temperature 60 °C
- permissible ambient temperature 0–45 °C
- power supply 230V/50 Hz
- electric power consumption 60 W
- electric rated current ≤ 3 A
- connections pressure side G ½"
- connections downstream side G ½"
- dissolved gas separation efficiency of up to 90 %
- max. system volume 1 m³ (applies only to the water content of heating surfaces and distribution lines, can be supplemented by a buffer tank of up to 1 m³)
- **Control Smart controller** via Bluetooth with lots of digital functions:
 - operating assistant for fault diagnosis, commissioning, service and maintenance

	Type	Art. No.	System volume V _A up to* [m ³]	Operating pressure [bar]	Electric power [kW]	Height h [mm]	Width w [mm]	Depth D [mm]	Weight [kg]
60 °C W, GL	Mini	8835800	1	0.5–2.5	0.06	420	295	220	5.60
Servitec Mini & Fillcontrol Plus Compact									
	Mini & Fillcontrol Plus Compact	8835900	1	0.5–2.5	0.06	420	295	220	8.60

*Max. system volumes for system degassing / max. make-up quantities must be taken into account for the specific system.

Servitec S



Servitec S

Servitec S – with a multiplicity of pre-installed digital functions

Technical Features

- permissible operating temperature 70 °C
- max. make-up output 0.080 m³/h
- power supply 230V/50 Hz
- connections for the make-up, pressure, outflow side G ½"
- dissolved gas separation efficiency of up to 90 %
- separation level, free gases to 100 %
- max. partial volume flow network 0.050 m³/h
- minimum inlet pressure make-up 0.10 bar
- sound pressure level 55 dB(A)
- **Control Smart controller** via Bluetooth with lots of digital functions:
 - integrated p₀ wizard for ideal commissioning
 - RS-485 interface and factory-fitted Modbus RTU
 - operating assistant for fault diagnosis, commissioning, service and maintenance

	Type	Art. No.	System volume V _A up to* [m ³]	System volume V _A GL up to* [m ³]	Operating pressure [bar]	Electric power [kW]	Height h [mm]	Width w [mm]	Depth D [mm]	Weight [kg]
Control Smart controller, suitable for water and water-glycol mixtures										
70 °C GL, W	S	8832000	6	4	0.5–4.5	0.20	572	340	211	13.80

* Max. system volumes for system degassing / max. make-up quantities must be taken into account for the specific system.

Commissioning

- **7945725**: Reflex commissioning Cat. 3 for Reflexomat Silent Compact Smart/Reflexomat XS/Servitec S with one compressor/one pump
- **7945726**: Reflex commissioning add. Cat. 3 for each additional system at the same location – one compressor/pump



Type	Art. No.	Weight [kg]
Commissioning Cat. 3	7945725	–
Commissioning add. Cat. 3	7945726	–

Servitec



Servitec 35 Control Basic

Servitec 60 Control Touch

Servitec 95 Control Basic

Technical
Features

- vacuum spray-tube degassing with integrated water make-up for systems with membrane expansion vessels or pressurisation systems
- permissible operating overpressure
 - type 35, 60: 8 bar
 - type 75, 95, 120: 10 bar
- max. make-up output
 - type 35: 0.350 m³/h
 - type 60, 75, 95, 120: 0.550 m³/h
- microprocessor controller with plain text display for pressure
- floating contact for group message
- easy commissioning thanks to Auto Setup
- Safe Control (make-up via motor ball valve, except Servitec 120)
- optional water make-up from a reservoir (user-supplied)
- flexible adjustment of the operating modes Servitec Magcontrol (for diaphragm expansion vessels) or Levelcontrol (for pressurisation units)
- centralised degassing of content and make-up water

Servitec



	Type	Art. No.	System volume V_A up to* [m ³]	System volume V_A GL up to* [m ³]	Operating pressure [bar]	Electric power [kW]	Height h [mm]	Width w [mm]	Depth D [mm]	Weight [kg]
Control Basic controller, suitable for water and water-glycol mixtures										
90 °C GL, W	35	8831100	220	50	0.5–2.5	0.75	965	553	486	31.40
	60	8831200	220	50	0.5–4.5	1.10	1,150	600	486	35.80
	75	8831300	220	50	1.3–5.4	1.10	1,150	573	633	50.60
	95	8831400	220	50	1.3–7.2	1.10	1,150	573	633	51.40
Control Touch control unit, suitable for water and water-glycol mixtures										
90 °C GL, W	35/T	8832100	220	50	0.5–2.5	0.85	965	553	486	34.40
	60/T	8832200	220	50	0.5–4.5	1.10	1,150	600	486	38.80
	75/T	8832300	220	50	1.3–5.4	1.10	1,150	573	633	53.60
	95/T	8832400	220	50	1.3–7.2	1.10	1,150	573	633	54.40
Control Touch control unit, suitable for water-glycol mixtures										
90 °C GL	Mag. 120/TGL	8832550	–	50	1.3–9.0	1.50	1,150	578	598	53.00
Control Touch control unit, suitable for water										
90 °C W	Mag. 120/T	8832500	220	–	1.3–9.0	1.50	1,150	578	598	53.00

 Custom designs upon request: System volume > 220 m³ and working pressure > 9.0 bar

* Max. system volumes for system degassing / max. make-up quantities must be taken into account for the specific system.

Servitec accessoires



Busmodule

- for exchanging data between controller and central building management system
- only bus modules type Ethernet and Profibus DP are suitable for a Control Basic controller



I/O module

- two additional analogue outputs for pressure and level control
- six freely programmable digital inlets
- six freely programmable floating outputs



Commissioning

- **7945600**: Reflex commissioning Cat. 1 for Reflexomat, Variomat, Servitec with one compressor/one pump
- **7945704**: Reflex commissioning add. Cat. 1 for each additional system at the same location – one compressor/pump



Type	Art. No.	Weight [kg]
Busmodule BACnet MS/TP*	8860600	0.10
Busmodule BACnet-IP Touch*	8860500	0.40
Busmodule Ethernet*	8860300	1.90
Busmodule Modbus RTU Touch*	9125592	0.20
Busmodule Profibus DP*	8860200	3.00
Busmodule Profibus DP Touch*	9118042	0.10
Commissioning Cat. 1	7945600	–
Commissioning add. Cat. 1	7945704	–
I/O module SE*	8860400	1.00

* can not be used with Servitec S

Selection and calculation

Servitec quick selection

The dimensions of the Servitec degassing system are dictated by the maximum operating pressure and volume of the facility, and the required make-up quantity.

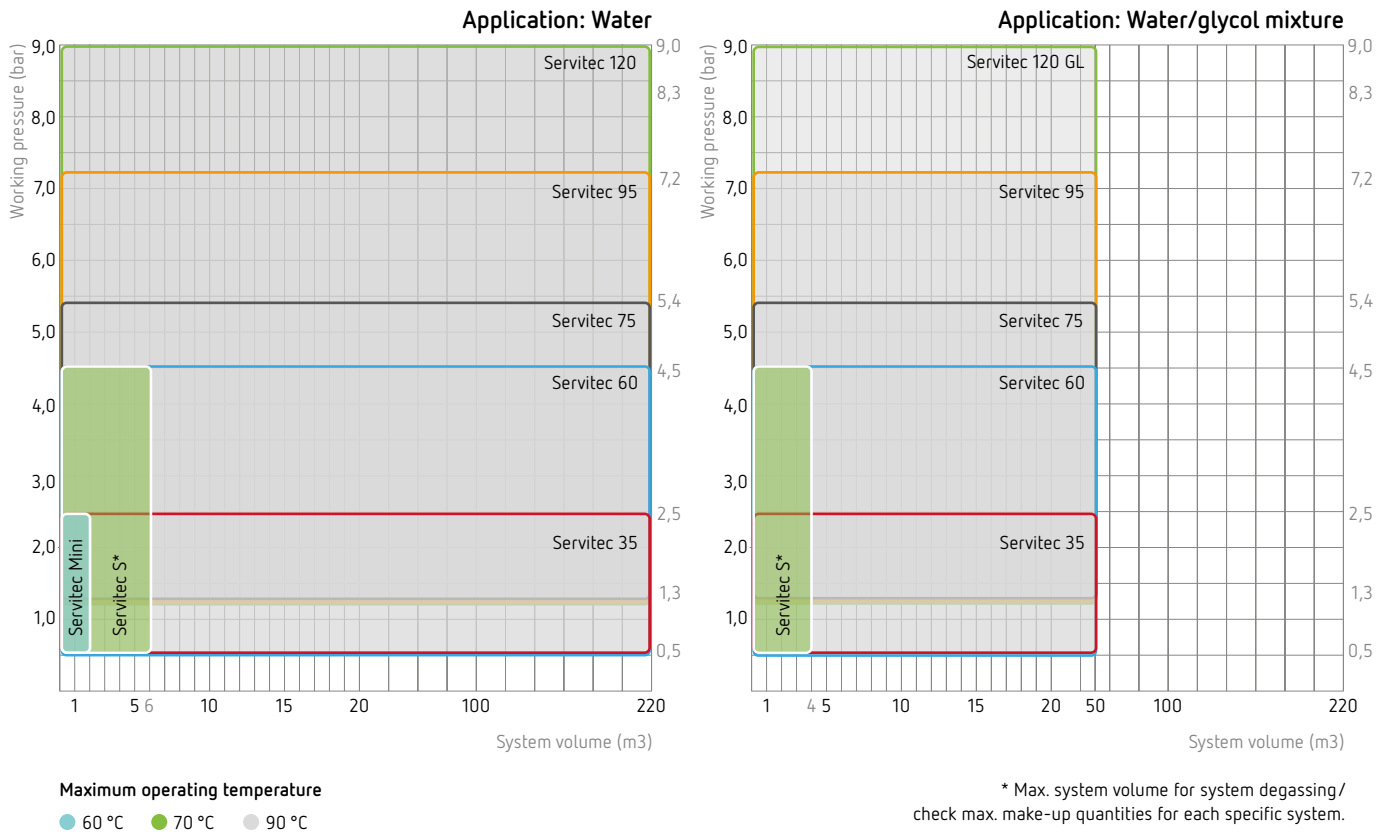

- The recommended system volumes are conditional upon the network volume being degassed, at least partially once a fortnight.
- Please bear in mind that —since Servitec can only be operated in the indicated pressure range— the pressure at the Servitec tie-in point must not be higher or lower than the indicated operating pressures. We recommend special solutions for non-standard conditions.
- The operating range of the equipment must be within the operating range of the pressure maintenance system between supply pressure p_a and final pressure p_e .
- **Recommendation:** Combining dirt and sludge separators produces very efficient synergies for optimising the operation of technical water facilities.

Customised planning with the Reflex Pro calculation program



Reflex Solutions Pro
rsp.reflex.de/en

Installation and commissioning

Installation notes

- Servitec must be connected to the system on the piping side.
- Servitec must be tied in on the facility side in the return flow and upstream of any return flow admixture.
- Installation in the main volume flow of the circuit water ensures optimum degassing performance.
- If connecting the Servitec make-up directly to Potable water networks, a system separator, such as Reflex Fillset, must be used.

Water feed notes

While the degassing cycle is running, no water is present in the degassing tank during creation of the vacuum. As such, this water must be accommodated by the pressure maintenance system and taken into account when calculating the relevant expansion volume in order to prevent pressure fluctuations in the system:

Servitec Mini	$V_D = 0,5 \text{ l}$
Servitec S	$V_D = 1,0 \text{ l}$
Servitec 35–120	$V_D = 6,0 \text{ l}$

Tie in

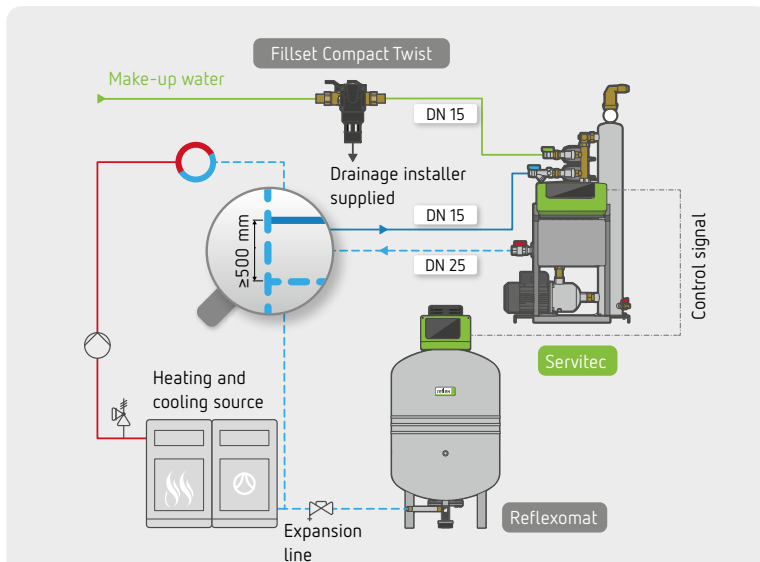

- If the pipe is > 25 m long, select a nominal diameter one size larger.
- If the make-up line is > 4 m long, a Reflex WG water shock arrestor must be installed between the Servitec and the make-up fitting (to balance out any temperature-related medium expansion).

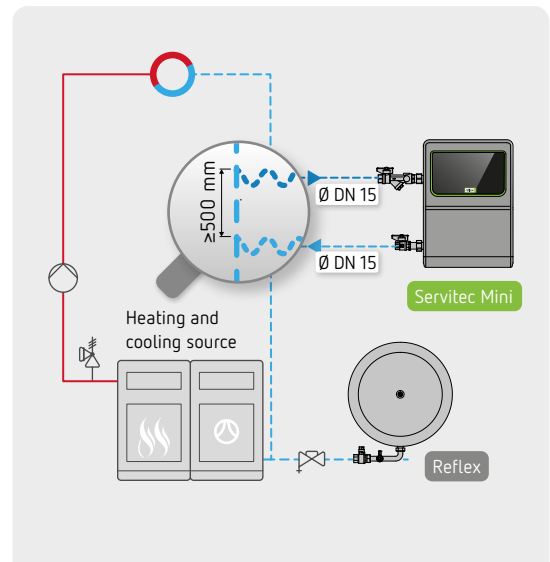

- Flexible hose connection to the existing piping network
- Use of shut-offs at the tie ins
- Max. pipe length 5 m

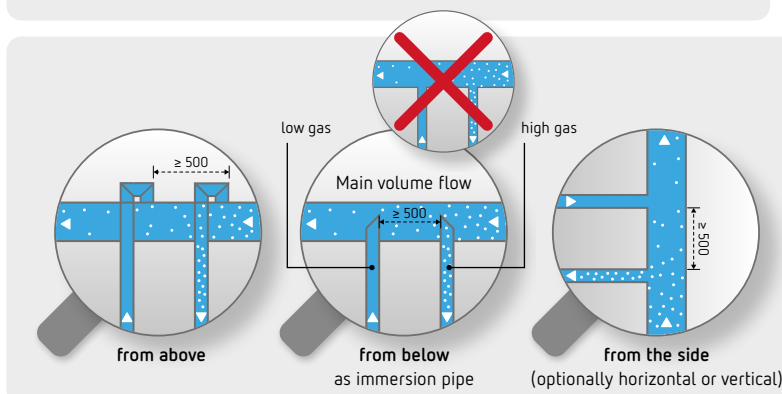

Detailed hydraulic tie in

- Tie in connection pipes from above, the side and below as an immersion pipe. Avoid butted tie ins from below at all times (risk of soiling).
- Observe minimum spacing of 500 mm between tie in points, consider the direction of flow and flush the pipelines.

Configuring the controller

1. Degassing mode

Continuous and interval degassing

- Continuous or interval degassing mode switches on and off at specific times
- Continuous degassing is generally performed during commissioning of after performing repairs. Interval degassing is activated automatically after continuous degassing.

Duration of continuous degassing

- Depending on the network volume;
Recommendation: if using water, run half of the network volume through Servitec once, if using water/glycol mixtures, five times the network volume

2. Water make-up operating modes

Levelcontrol mode

For facilities with pump- or compressor-controlled pressure maintenance stations with level-dependent water make-up

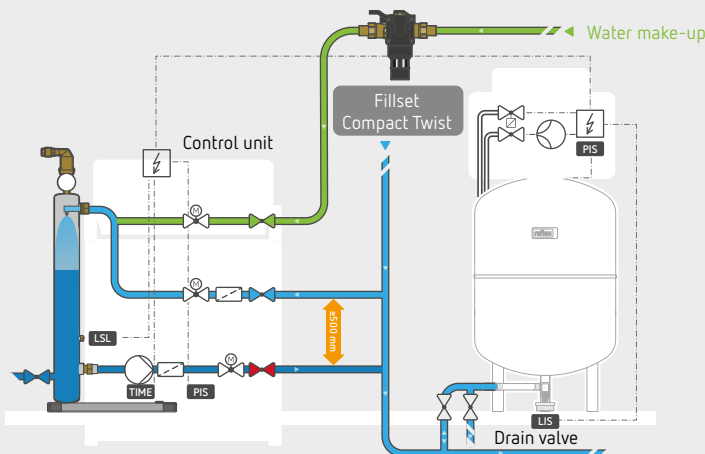

LIS

Filling, level-dependent water make-up, Levelcontrol

- Automatic, controlled make-up if the water in the expansion vessel of the pump- or compressor-controlled pressure maintenance station falls below the minimum level
- Servitec degassing of the make-up water

PIS

Filling, pressure-dependent water make-up, Magcontrol

- Pressure is shown on the display
- Pressure above and below the permissible range is signalled
- Automatic, controlled make-up when filling pressure drops below 0.2 bar
- Servitec degassing of the make-up and filling water

Magcontrol mode

For facilities with diaphragm expansion vessels with pressure-dependent water make-up

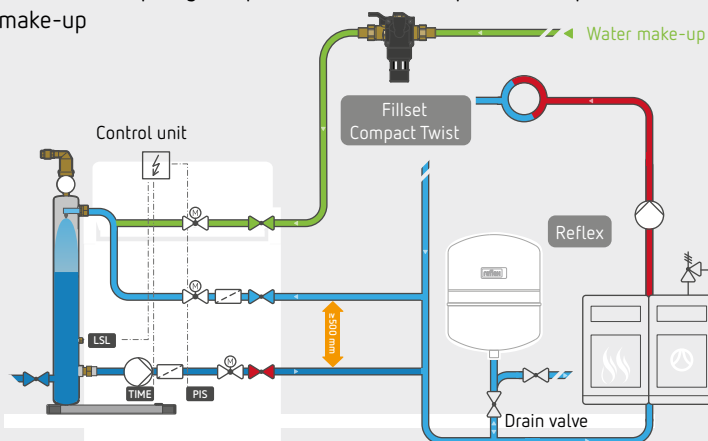

TIME

Degassing

- Vacuum degassing of a partial flow of the circuit water as per an optimised schedule with selectable degassing mode
- Continuous degassing (after commissioning)
- Interval degassing (automatically activated after continuous degassing)

Tender texts, data sheets, CAD web catalogue incl. BIM data are available at www.reflex-winkelmann.com/en



3. Setting the minimum operating pressure

The minimum operating pressure and safety valve pressure must be set in Magcontrol mode.

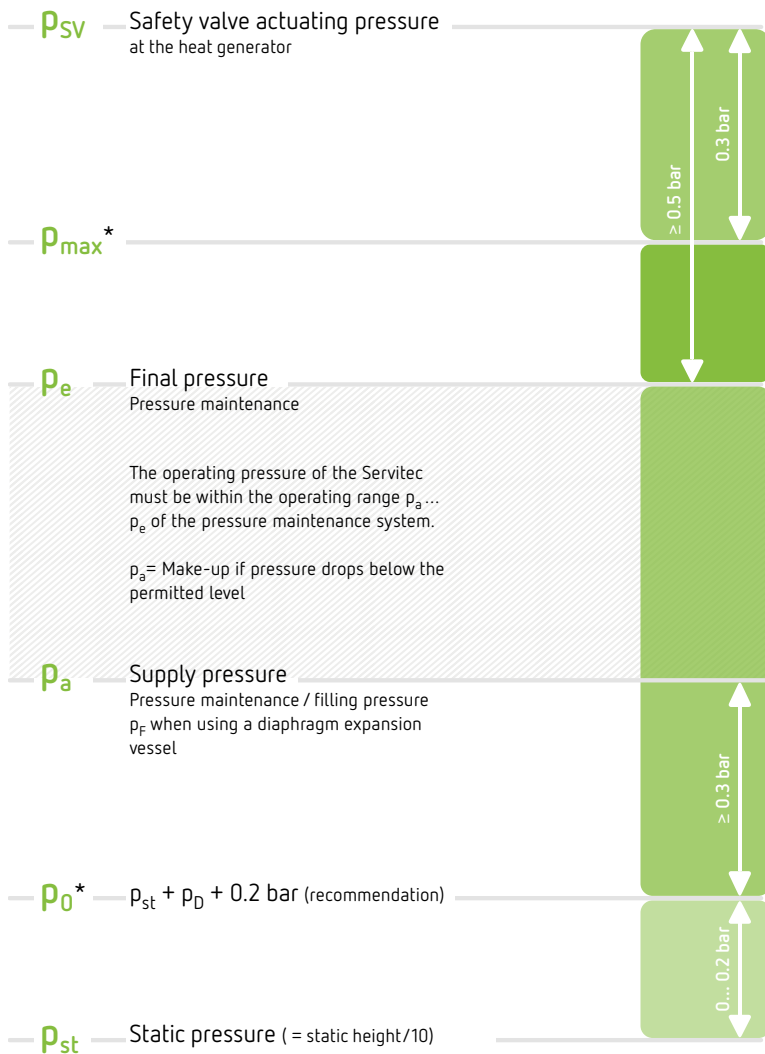

P_{sv}
 When selecting the right Servitec for your system, please always consider the actuating pressure of the safety valve relative to the max. operating pressure. System parameters may be amended or adjusted over time to ensure that your Servitec is always covering the full pressure range of the system.

P_0
 Set the appropriate minimum operating pressure on your Servitec for the static height of your facility. Water make-up is regulated automatically, depending on pressure levels, in the relevant operating modes.

* Fault message if pressure is higher or lower than permitted

The following example uses a Servitec 35 in Magcontrol mode to visualise the design parameters relative to the appropriate pressure parameters.	Basic technical data Supply temperature = 70 °C (evaporating pressure p_D = 0 bar) Static pressure p_{st} = 11 mWS (11 mWS ~ 1.1 bar)	Settings Servitec p_0 ($p_{st} + p_D + 0.2 \text{ bar}$ (recommendation)) = 1.3 bar P_{sv} = 3.0 bar	Example: Heating system
	Resulting pressures of relevance for make-up In = 1.4 bar Out = 1.6 bar		

Installation examples

Solution No 01 Servitec Mini with Fillcontrol Plus Compact

Servitec Mini with automatic water make-up via Fillcontrol Plus Compact for direct connection to the potable water supply system. An external pressure sensor is required when using Fillcontrol Plus Compact with Fillsoft.

Servitec Mini must always be tied into the return flow, in the direction of flow.

To ensure compliance with VDI 2035, use Fillsoft with a softening or demineralising cartridge (depending on the quality of the water and the specifications of the boiler manufacturer).

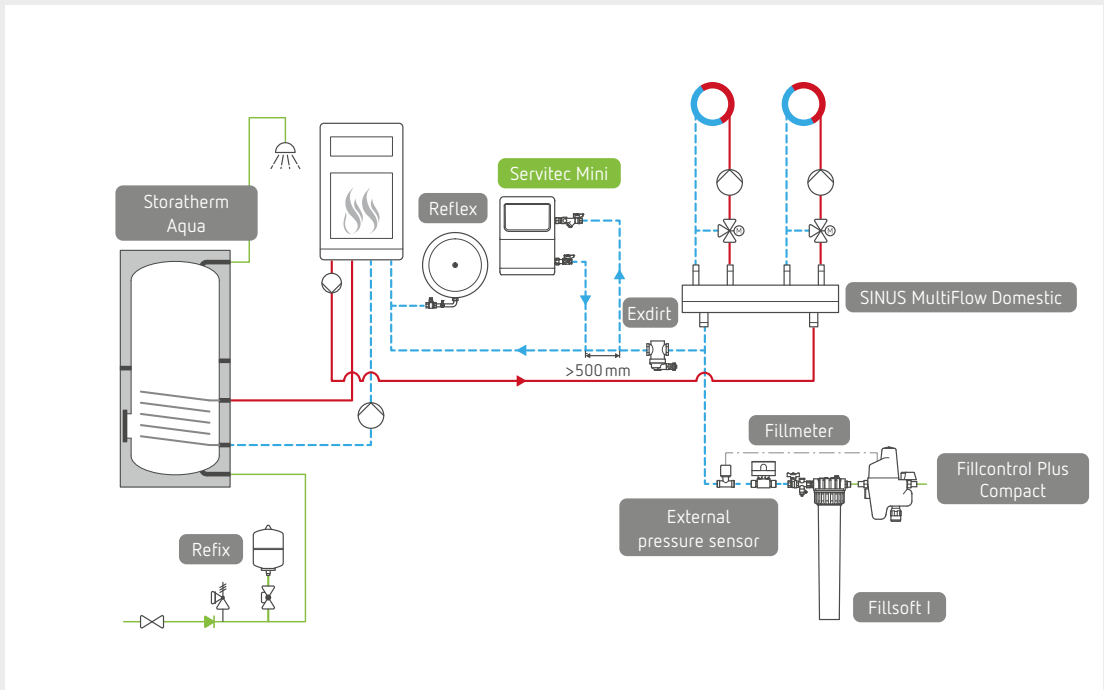

Solution No 18 Servitec with Reflexomat and Fillsoft

An electrical connection must be planned on site to enable communication between Servitec and Reflexomat (both appliances must be fitted with a pressure sensor).

Set Servitec to Levelcontrol mode.

When connecting Servitec to potable water supply systems, integrate a system separator such as Fillset Impuls with contact water meter. The contact water meter is read by the Servitec controller.

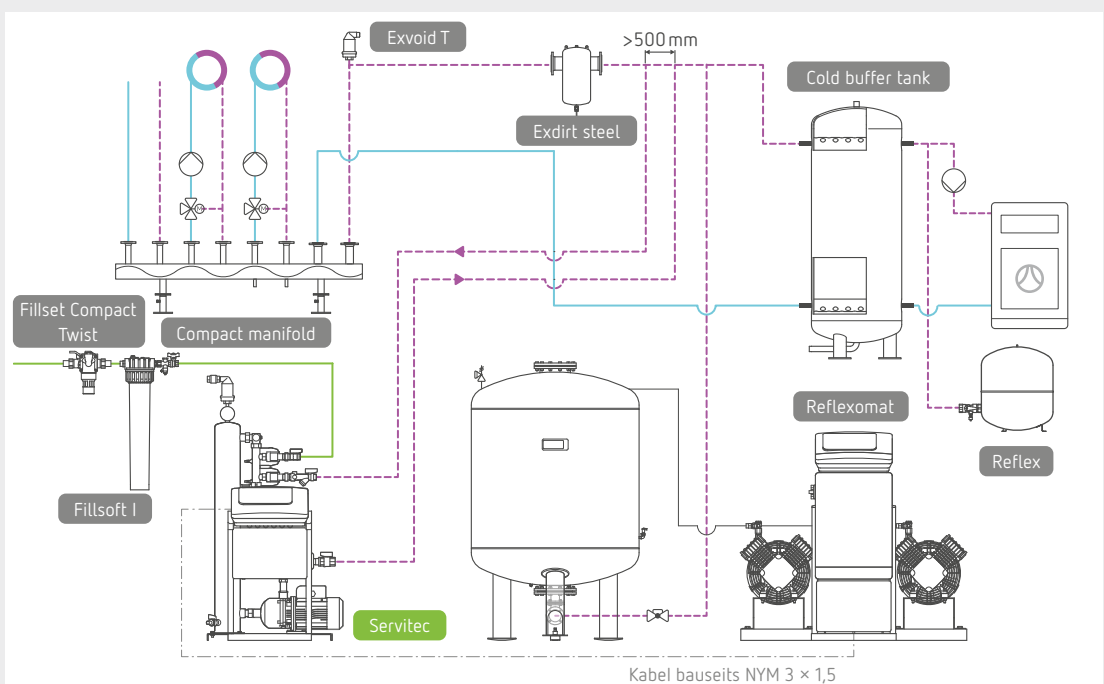

Servitec with Variomat and SINUS EasyFixx

Solution No 11

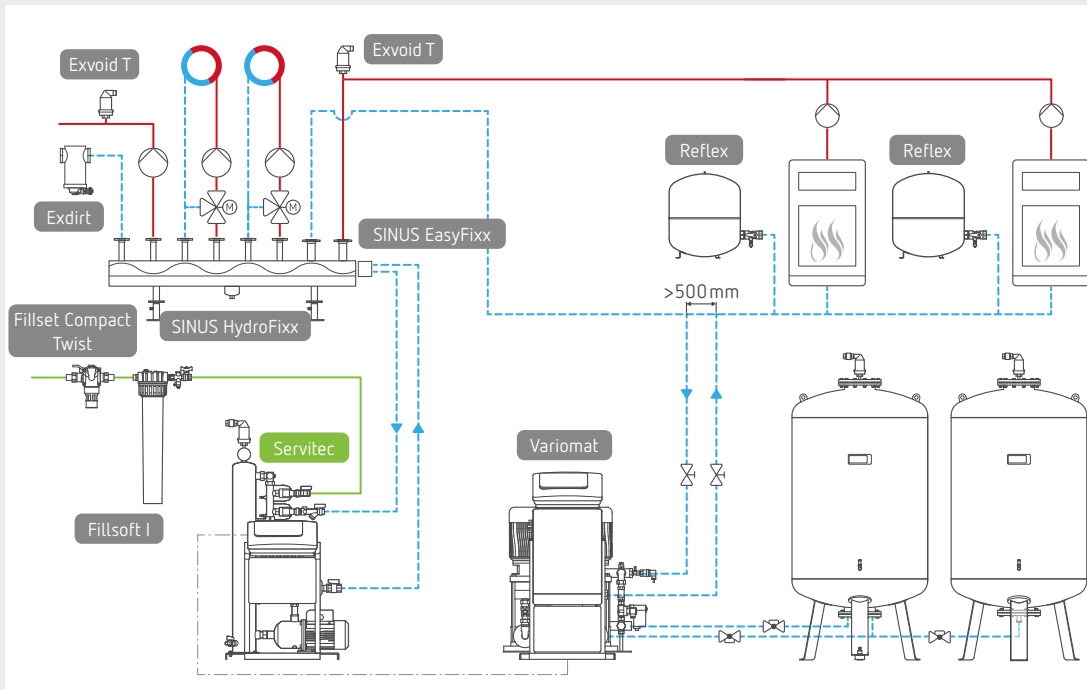

Use of Servitec to achieve maximum degassing performance. Deactivate degassing on the Variomat.

When combining Servitec and Variomat, include Reflex diaphragm expansion vessels in the design to safeguard each boiler individually and to act as control vessels.

Sinus EasyFixx is a simple and fault-free means of connecting Servitec; it enables direct connection to the manifold and optimises the hydraulic tie in to the pressure raising system.

Customised Servitec with Variomat Giga in cold water system

Solution No 21

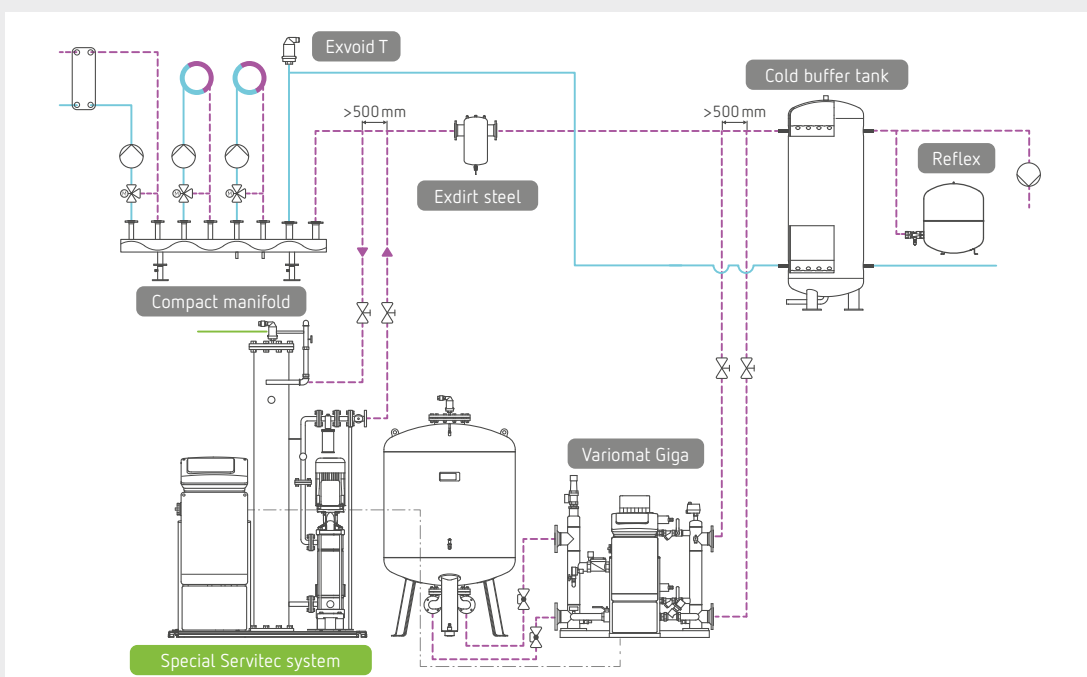

Customised Servitec with high-performance Variomat Giga pressure maintenance for challenging requirements.

Reflex expansion vessel to individually safeguard the cold source.

To maximise efficiency and operational reliability when using Servitec, install an Exdirt dirt and sludge separator.

The diagram is only meant to visualise the interconnections. Installation must be adapted to local conditions accordingly and must be specified in more detail.

Special solutions

Systems of all sizes and complexities

In addition to our standard portfolio, we can also design and manufacture Servitec systems to customer specifications and in larger sizes. Many of our customised Servitec systems are in use around the globe, where they have been tailored to all sorts of specific customer requirements. Our strength lies in supporting and planning comprehensive projects and facilities for high performance, high pressures, and high water temperatures.



What we can offer

- Higher flow rates and system volumes
- Higher operating pressures
- Lower or higher operating temperatures
- Stainless steel models
- Special cold water applications

Your benefits

- Years of experience in all areas of special solutions (power plants, district heating systems, geothermal systems, etc.)
- Hot water system certification as per EN 12953 and TRD 604
- International team with local knowledge
- Highest quality standards
- Tested processes
- Broad spectrum of activities (virtually no limitations in respect of facility size, pressures, temperatures, makes)
- Specialists for all sorts of special solutions
- Incorporation of international standards, such as ASME, ANSI etc.



Temperatures up to
300 °C



System capacities up to
800 MW



Pressures up to
PN 25



System volumes up to
18,000 m³
+ Make-up volumes up to
15 m³ h

Selected references



Heating plant, Hamm municipal utilities

Product solution

Servitec special system

Customer-specific requirement

Large water make-up quantity

Objective achieved

Reduction in the large quantity of chemicals used to bind oxygen because the expansion vessel was open to the atmosphere.

System parameters

Capacity:	20 MW
System pressure:	7 bar
Temperature:	130/64 °C
System volume:	approx. 890 m ³
Servitec degassing performance:	7 m ³ /h



Böblingen municipal utilities

Product solution

Servitec special system

Customer-specific requirement

High performance parameters
(temperatures and volumes)

Objective achieved

Optimised system operation without malfunctions,
and maintenance reduced by 60 %

System parameters

Capacity:	49 MW
System pressure:	7 bar
Temperature:	130/80 °C
System volume:	approx. 1,200 m ³
Servitec degassing performance:	12 m ³ /h

Reflex added value

Our digital services



Reflex Solutions Pro —

complete product solutions quickly and easily

The next generation of the proven configuration tool allows products from the entire Reflex portfolio to be individually compiled and configured to suit a specific system, irrespective of size — from a single-family home to residential buildings

and industrial premises. Whether a single product or a complete system, just choose the application, then enter the relevant system parameters, Reflex Solutions Pro works out the appropriate configuration quickly and precisely. With one click, you can download the complete documentation such as product data, tender texts and BIM data.

Start designing your configuration now for free:



rsp.reflex.de/en

Reflex Training — expertise gives us the edge



Close to our headquarters in Ahlen, professional craftsmen, planners and operators gear up to meet the challenges posed by heating and hot water supply in modern building technology. From installation and planning to consulting and technical operation, the Reflex Training Centre and its team aligns its programme to those partners who want to learn more about technology, standards and service from the horse's mouth.

Newly acquired expertise is put into practice, refined and experienced straight away on Reflex systems in a former manor house that has been refurbished to modern-day standards in the German region of Westphalia. Realistic simulations and a comprehensive portfolio of systems help to put the content learned to practical use, skilfully combining theory with practical aspects. The Reflex4Experts training courses are now also available online, for example, as webinars for PC, tablet or smartphone, and include short, interesting learning units on current and exciting topics that can be easily followed in the office, at home or on the road.

More information is available at www.reflex4experts.com/en

Reflex Training Center

+49 2382 7069-9581
seminare@reflex.de



Our performance promise — Reflex After Sales & Service

Supply technology systems are becoming increasingly complex. This is true for the technology as well for documentation and testing requirements. With Reflex After Sales & Service, you remain in good hands after your purchase. Our years of expertise specialising in the Reflex product world ensure the full safety and functionality of your system.

- Expertise and many years of experience with all Reflex products
- Qualified personnel with expertise in the latest products and guidelines

- Compliance with statutory regulations and therefore also with liability and warranty provisions
- Systems optimally adapted for maximum efficiency and functionality

You can find more information about all our services at www.reflex-winkelmann.com/en/services/after-sales-and-service



Warranty extension to five years

From now on, you can register your system after it has been commissioned by us or by a service partner certified by us. If you enter into a maintenance contract at the same time, you are entitled to a warranty extension to five years. Take advantage of this opportunity easily at www.reflex-winkelmann.com/en/services/after-sales-and-service/warranty on our home page or simply use the sticker on your product to access registration.

Registration is not only possible at the time of commissioning but is also valid for all systems with a manufacturing date of up to six months from the year of manufacture 2020.

With the new online service order, we are optimising the service for our customers even further. It takes just a few clicks to create the order form, and it can be processed directly in our system. This makes our service even faster and more customer friendly.



Technical hotline

+49 2382 7069-9546
aftersales@reflex.de



Factory service centre

+49 2382 7069-9505
aftersales@reflex.de



Commercial processing

+49 2382 7069-7505
aftersales@reflex.de



A series of horizontal dotted lines for writing notes.

Discover Reflex with augmented reality



1 Scan QR-Code.
reflex.de/en/city



2 Download the
Reflex Smart City app



3 Scan the title of this
brochure and explore

Always up to date

Further product literature and materials can be downloaded at or hard copies ordered from www.reflex-winkelmann.com/en/services/documents-and-videos



Thinking solutions.

Reflex Winkelmann GmbH
Gersteinstrasse 19
DE-59227 Ahlen
+49 2382 7069-0
info@reflex.de

www.reflex-winkelmann.com/en